

Bidirectional Buck-Boost Controller with I²C Interface and EPC GaN FET

General Description

The RT6190 is a bidirectional Buck-Boost controller designed for USB power delivery (USB-PD). It can deliver up to 140W power with maximum 5A current under $V_{OUT} = 28V$ condition with EPC Gallium Nitride FET. This document explains the function and use of the RT6190 evaluation board (EVB) and provides information for the evaluation board schematic, layout, and bill of materials (BOM) to suit individual requirements.

Table of Contents

General Description	1
Performance Specification Summary	2
Detailed Description of Hardware	3
Bill of Materials.....	6
Quick Start with RTMCU WRENBOARD.....	8
Typical Applications	11
Evaluation Board Layout.....	15
More Information.....	17
Important Notice for Richtek Evaluation Board.....	17

Performance Specification Summary

The RT6190 is a bidirectional Buck-Boost controller designed for USB power delivery (USB-PD) with an input supply voltage range of 4.5V to 36V in a WQFN-40L 5x5 package. The device is mounted on a four-layer evaluation board (EVB) in size of 110mm x 60mm with 1oz copper thickness.

Table 1. RT6190 Evaluation Board Performance Specification Summary

Key Features	EVB Parameter
Input Range	
Input Voltage	12V to 24V
Enable Input Voltage	2V to 24V
ALERT Pin Pull-High Voltage	1.8V or 3.3V
Output Range	
Output Voltage	5V to 28V
Maximum Output Current	5A
Maximum Overcurrent Protection	6.5A
Maximum Output Power	140W
Switching Frequency and Package	
Operating Frequency	250kHz (typ.) in FCCM
Package	WQFN-40L 5x5

Detailed Description of Hardware

Headers Description and Placement

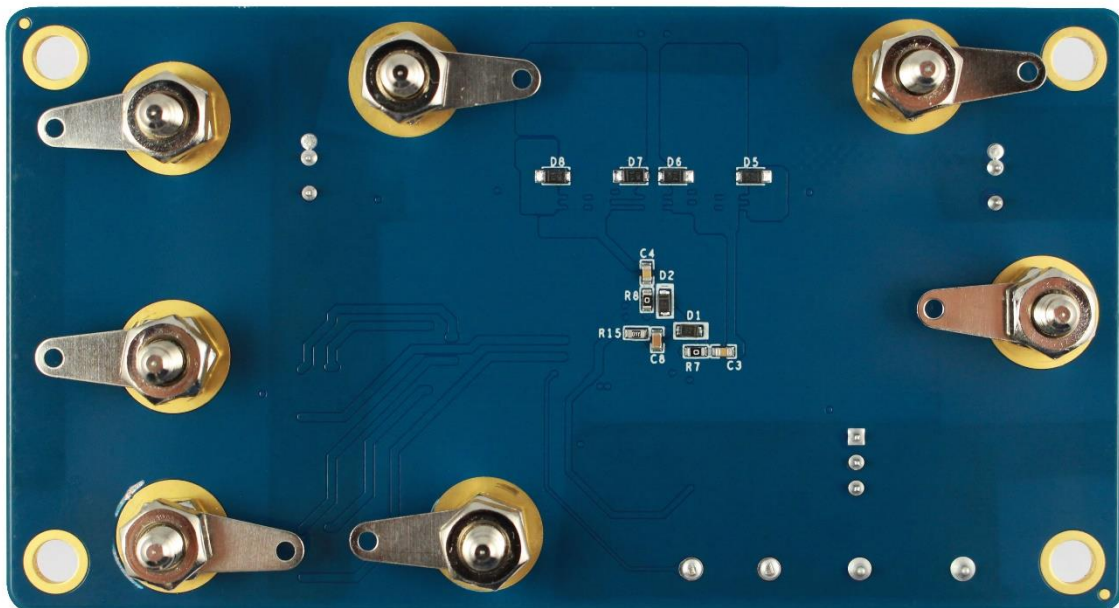
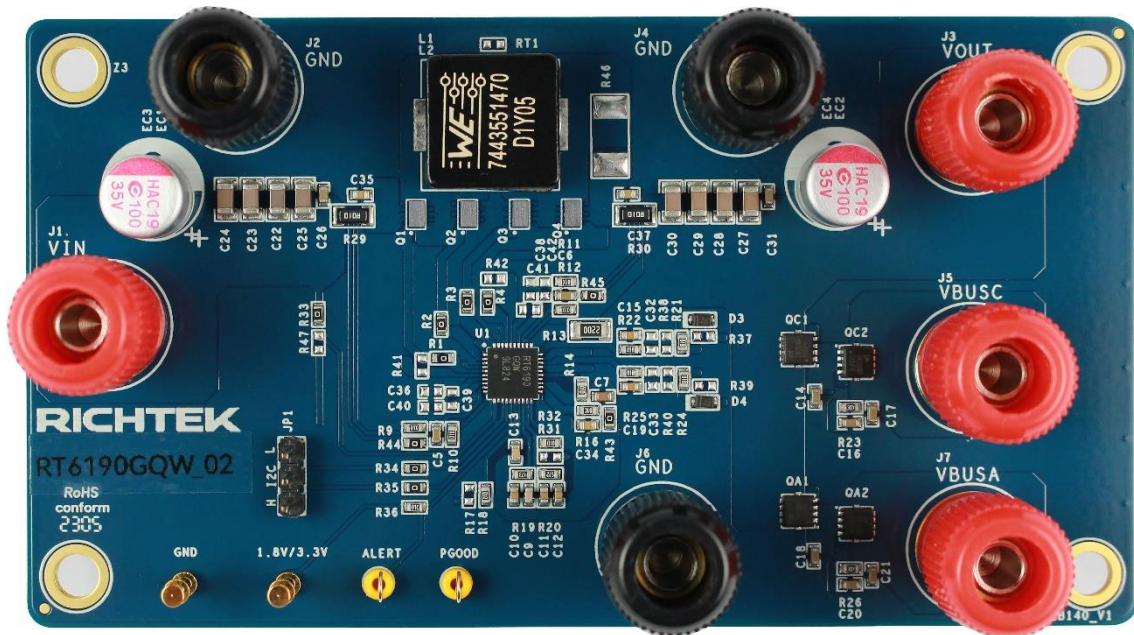

Carefully inspect all the components used in the EVB according to the following Bill of Materials table, and then make sure all the components are undamaged and correctly installed. If there is any missing or damaged component, which may occur during transportation, please contact our distributors or e-mail us at evb_service@richtek.com.

Test Points

The EVB is provided with the test points and pin names listed in the table below.

Test Point	Pin Name	Expected Waveforms or Voltage Levels on Test Points
J1	VIN	(1) Positive/Negative terminals for input voltage from power supply to EVB in Forward operation. (2) Positive/Negative terminals for output voltage from EVB to e-load in Reverse operation.
J2	GND	
J3	VOUT	Positive terminal for output voltage from EVB to e-load.
J4	GND	(1) Negative terminal of output voltage and Power Path C from EVB to e-load in Forward operation. (2) Negative terminal of input voltage from power supply to EVB in Reverse operation.
J5	VBUSC	(1) Positive terminal for Power Path C from EVB to e-load in Forward operation. (2) Positive terminal for input voltage from power supply to EVB in Reverse operation.
J6	GND	Positive/Negative terminals for Power Path A from EVB to e-load.
J7	VBUSA	
JP1	I2C	Connection for I ² C interface.
GP1	1.8V/3.3V	External power supply for pull-high voltage of ALERT pin.
GP2	GND	Reference voltage for test points.
TP1	PGOOD	Test point for PGOOD measurement.
TP2	ALERT	Test point for ALERT measurement.

Power-up & Measurement Procedure

(1) Forward Operation

- Connect input power supply with wire as wide and short as possible to J1/J2 terminals.
- Connect EN to input voltage though R33, but R47 is NC.
- Connect an external load up to 5A to J4/J5 terminals.
- Set input voltage = 12V and 10A input current limit of input power supply.
- Connect I2C to JP1 pin header, and set register by I²C interface:
 - ◆ Set 0x0E = 90h to enable RT6190.
 - ◆ Set 0x29 = 02h to turn on power path C for VBUSC enabled.
- Status check when power on sequence finished:
 - ◆ VOUT = 5V at J3/J4 terminals.
 - ◆ VBUSC = 5V at J5/J4 terminals.
 - ◆ 0x1E = 00h and 0x1F = 40h.

(2) Reverse Operation

- Connect input power supply with wire as wide and short as possible to J5/J4 terminals.
- Connect EN to input voltage though R47, but R33 is NC.
- Connect an external load up to 5A to J1/J2 terminals.
- Set input voltage = 12V and 10A input current limit of input power supply.
- Connect I2C to JP2 pin header, and set register by I²C interface:

- ◆ Set 0x0C = 52h for power role swap.
- ◆ Set 0x29 = 02h to turn on power path C.
- ◆ Set 0x0E = 90h to enable RT6190.
- Status check when power on sequence finished:
 - ◆ VOUT = 5V at J1/J2 terminals.
 - ◆ 0x1E = 00h and 0x1F = 40h.

Noticafication

- (1) For other functions, please refer to RT6190 datasheet for detailed description.
- (2) The input and output current should not be higher than 9A due to power dissipation of the input and output current sense resistors are all 1W in 1206 size.

Bill of Materials

Reference	Qty	Part Number	Description	Package	Manufacturer
U1	1	RT6190GQW	Buck-Boost PWM Controller	WQFN-40L 5x5	Richtek
L1	1	7443551470	4.7 μ H/7m Ω /15A	12.8x12.8x6.2mm	WÜRTH ELEKTRONIK
L2	1	--	NC	--	--
Q1, Q2, Q3, Q4	4	EPC2204	N-MOSFET for Power Stage (100V/29A)	2.5x1.5mm	Efficient Power Conversion
QC1, QC2, QA1, QA2	4	SM3430NHQA	N-MOSFET for USB-C/A Power Path (40V/36A)	DFN3.3x3.3A-8_EP	Sinopower
D1, D2, D3, D4	4	1N4148WT-7	Diode (100V/0.25W) (1) External BOOT Voltage for SW1 and SW2 (2) Discharge QC1, QC2, QA1, QA2	SOD-523	Diodes
D5, D6, D7, D8	4	V1P6	Schottky Diode (60V/1A)	DO-219AD	Vishay
EC1, EC2	2	--	NC	--	--
EC3, EC4	2	350ARHA101M08X8	100 μ F/35V	8x3.5mm	APAQ
C3, C4, C34, C35, C37	5	0603B104K500CT	0.1 μ F/50V/X7R/0603	C-0603	WALSIN
C5, C6, C14, C16, C17, C18, C20, C21, C26, C31	10	GRM188R61H105KAALD	1 μ F/50V/X7R/0603	C-0603	MURATA
C7, C8	2	GRM188R61E475KE11D	4.7 μ F/10V/X5R/0603	C-0603	MURATA
C9	1	0603N1R0C500CT	1pF/50V/NPO/0603	C-0603	WALSIN
C10	1	0603B332K500CT	3.3nF/50V/X7R/0603	C-0603	WALSIN
C11	1	0603N221J500CT	220pF/50V/NPO/0603	C-0603	WALSIN
C12	1	0603B103K500CT	10nF/50V/X7R/0603	C-0603	WALSIN
C13	1	0603B333K500CT	33nF/50V/X7R/0603	C-0603	WALSIN
C15, C19	2	0603B152K500CT	1.5nF/50V/X7R/0603	C-0603	WALSIN
C22, C23, C24, C25, C27, C28, C29, C30	8	1206X106K500CT	10 μ F/50V/X5R/1206	C-1206	WALSIN
C32, C33, C36, C38, C39, C40, C41, C42	8	--	NC	--	--

Reference	Qty	Part Number	Description	Package	Manufacturer
R1, R2, R3, R4, R7, R8, R33, R34, R35, R43, R44, R45	12	WR06X000 PTL	0/0603	R-0603	WALSIN
R9, R10, R11, R12	4	WR06X10R0FTL	10/0603/1%	R-0603	WALSIN
R13	1	WR12X2200FTL	220/1206/1%	R-0603	WALSIN
R14, R18, R32	3	WR06X1003FTL	100k/0603/1%	R-0603	WALSIN
R15	1	WR06W1R00FTL	1/0603/1%	R-0603	WALSIN
R16, R36	2	WR06X1002FTL	10k/0603/1%	R-0603	WALSIN
R17, R31, R37, R38, R39, R40, R41, R42	8	--	NC	--	--
R19	1	WR06X4702FTL	47k/0603/1%	R-0603	WALSIN
R20	1	WR06X5101FTL	5.1k/0603/1%	R-0603	WALSIN
R21, R22, R24, R25	4	WR06X1001FTL	1k/0603/1%	R-0603	WALSIN
R23, R26	2	WR06W2R00FTL	2/0603/1%	R-0603	WALSIN
R29, R30	2	RLM-1632-6F-R010-FNH	10mΩ/1%/1206 for input/output current sense	R-1206	Cyntec
R46	1	--	NC	--	--
RT1	1	--	NC	--	--

Quick Start with RTMCU WRENBOARD

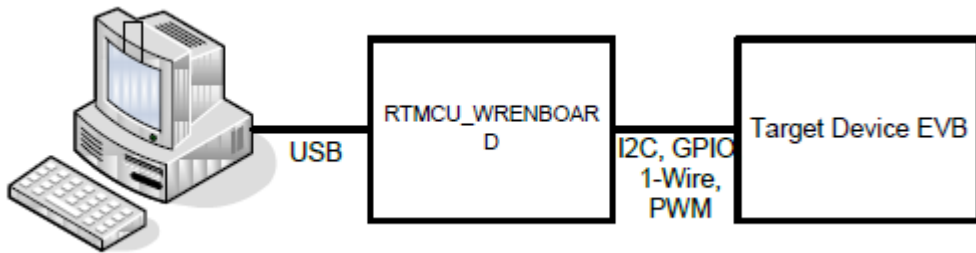

The following summarizes the contents of the Richtek MCU bridge board. In addition to hardware kits, one software utilities is needed to be installed for RTMCU_WRENBOARD bridgeboard.

- Richtek MCU bridge board (RTMCU_WRENBOARD).
- USB B type to micro 5 Pins cable to connect PC and the MCU bridge board. (optional)
- RTBridgeboardUtilities.exe.

RTMCU_WRENBOARD Hardware Description

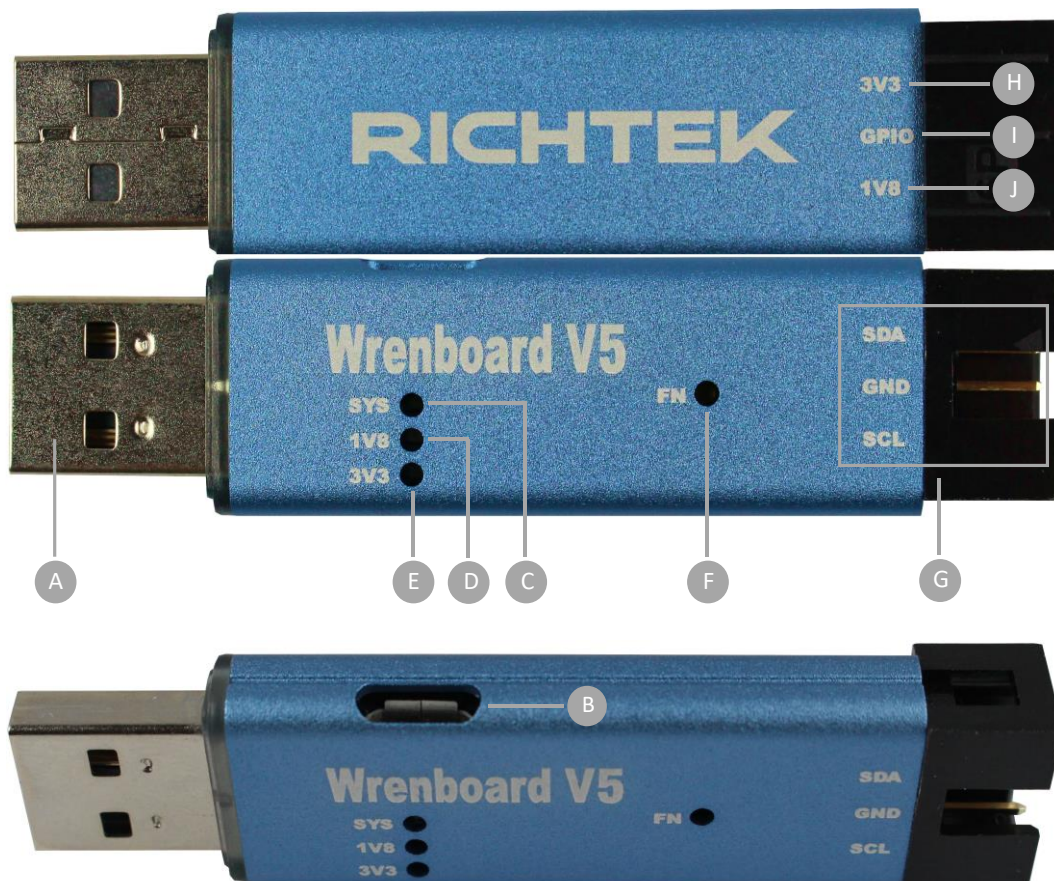

Function Description

- A. Standard USB A plug. It connects to PC directly.
- B. Micro 5 pin USB port. It connects to PC by USB cable.
 - It is an alternative to connect RTMCU_WRENBOARD to PC when long distance between PC and Device is needed.
- C. White LED Indicator
 - The white LED indicates RTMCU_WRENBOARD command execution.
- D. Blue LED Indicator
 - The blue LED indicates I²C (SCL and SDA) are operated in 1.8V.
- E. Red LED Indicator
 - The red LED indicates I²C (SCL and SDA) are operated in 3.3V.
- F. Red LED Indicator. This button has two functions:
 - To exchange I²C signals between 3.3V and 1.8V.
 - To enable firmware download function.
- G. I2C and GND pins
 - I²C pins (SDA, GND and SCL) in 3.3V or 1.8V level depend on user setting.
- H. Power pins
 - Power pins with 3.3V and 1.8V. It is suggested to limit the output current within 100mA for each power pins.
- I. GPIO
 - User can connect this pin to control device in either function.

The item A/B/C/D/E/G are used for RT6190 EVB.

I²C Control Panel Interface

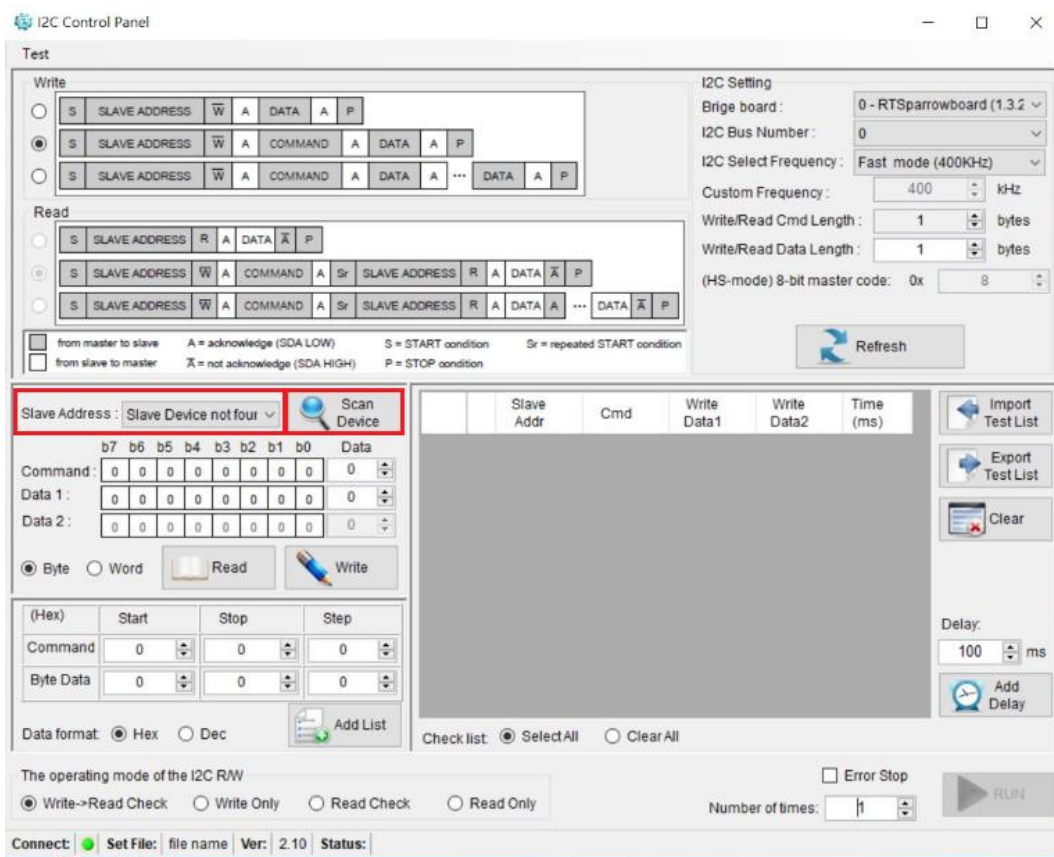

After VIN and EN are ready, and press “Scan Device” button, then “Slave Address” will show 0x2C or 0x2D to indicate RT6190 that can receive I²C command.

Typical Applications

EVB Schematic Diagram

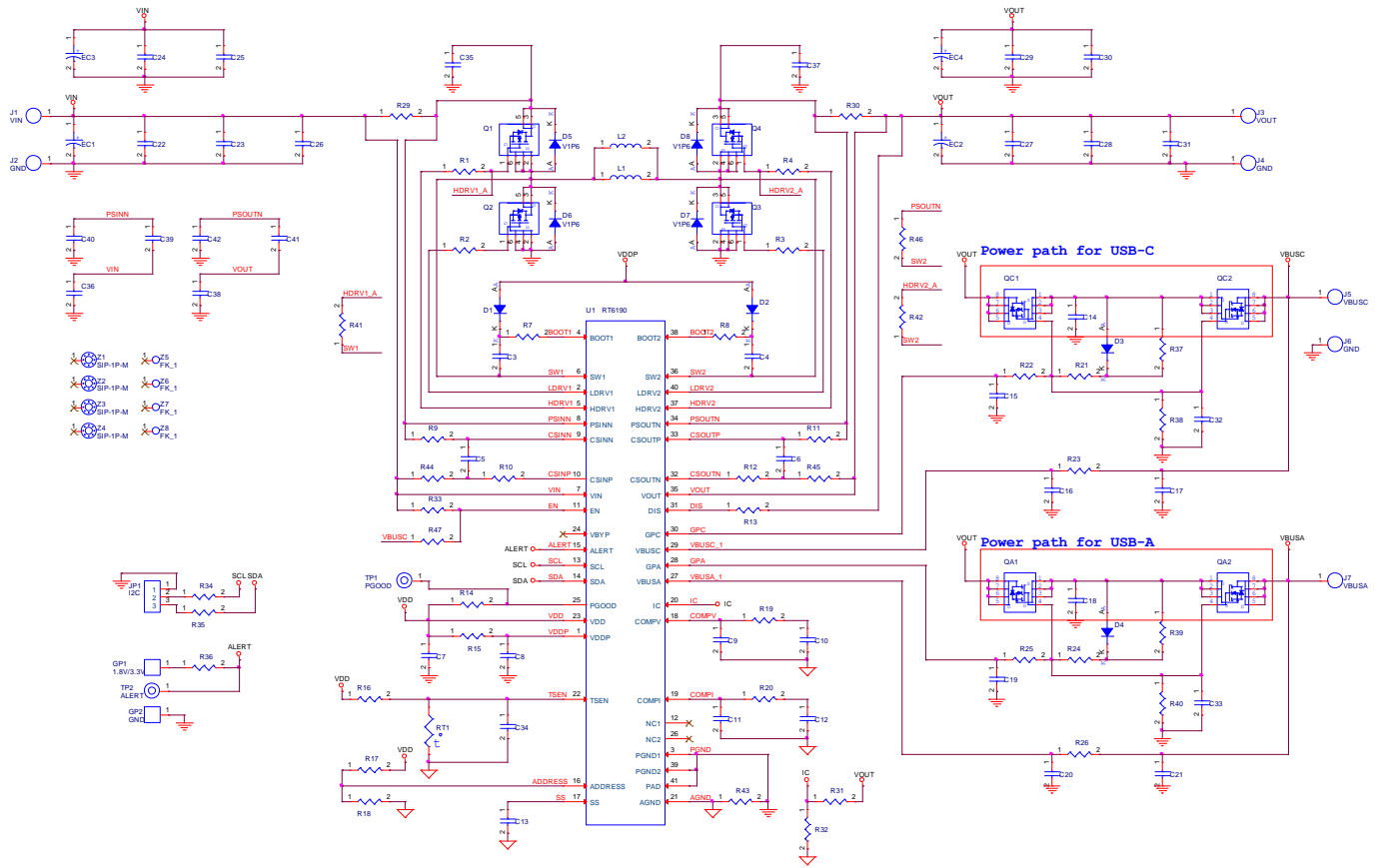

- (1) I²C slave address is 0x2C when R17 = NC, R18 = 100kΩ.
- (2) I²C slave address is 0x2D when R17 = 100kΩ, R18 = NC.

Measure Result

Efficiency @ $V_{OUT} = 5V$

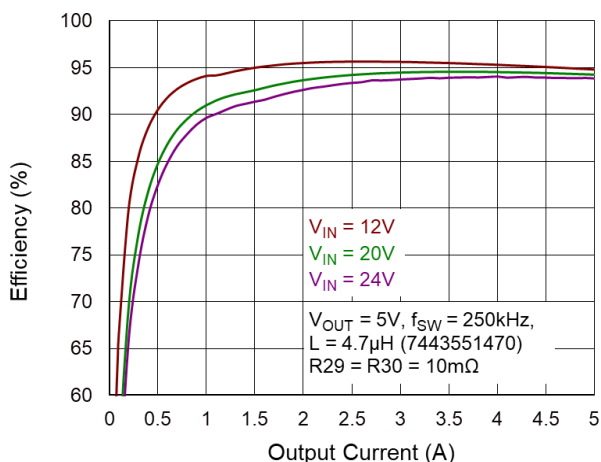

Efficiency @ $V_{OUT} = 9V$

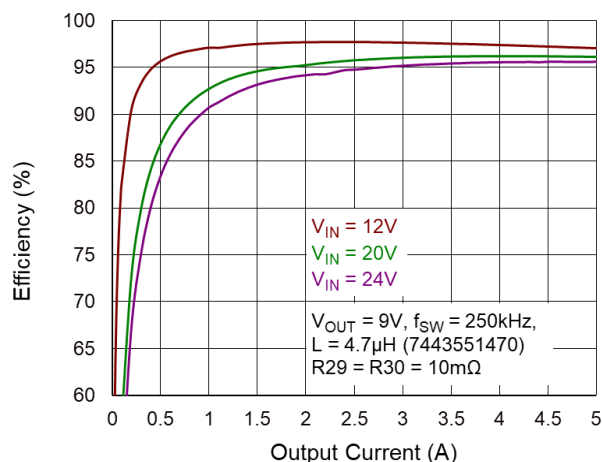

Efficiency @ $V_{OUT} = 12V$

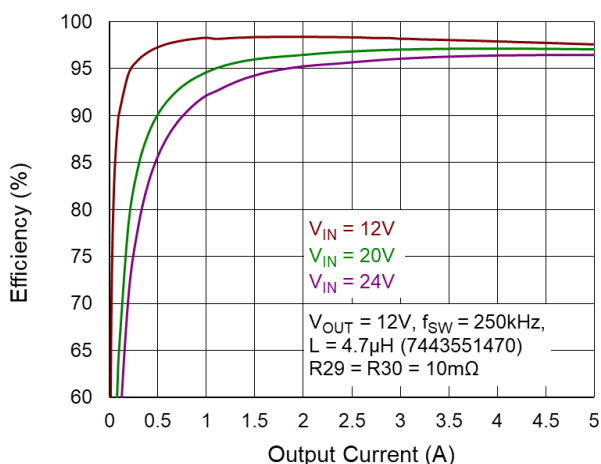

Efficiency @ $V_{OUT} = 15V$

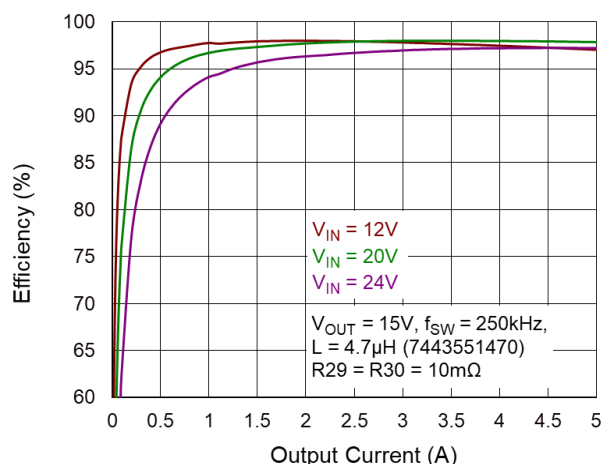

Efficiency @ $V_{OUT} = 20V$

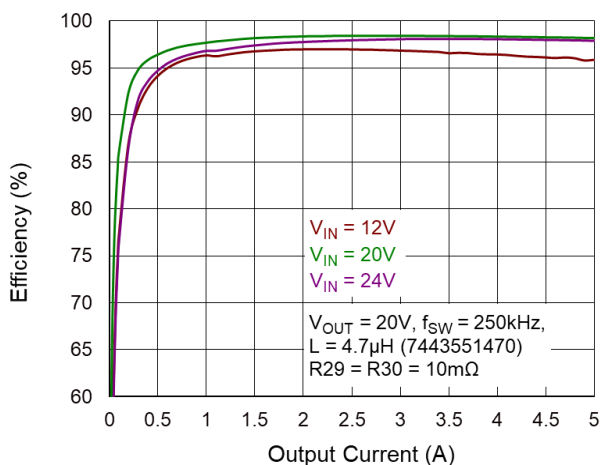

Efficiency @ $V_{OUT} = 28V$

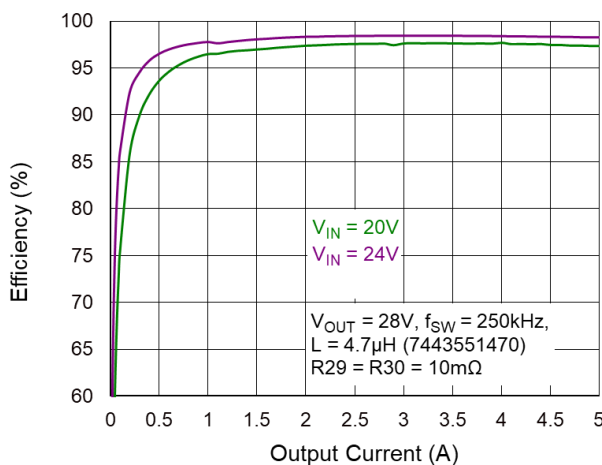

Forward Buck Mode Output Ripple Voltage

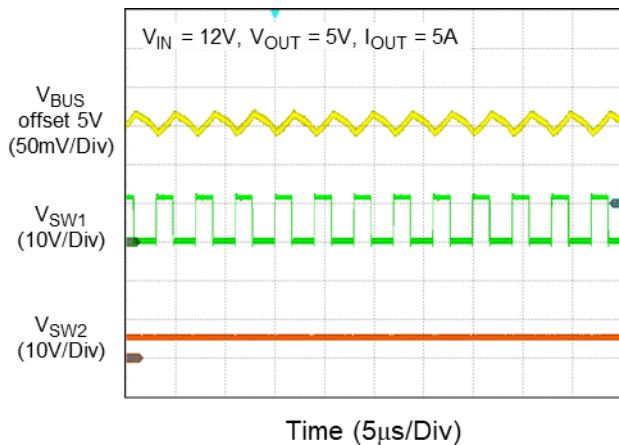

Reverse Buck Mode Output Ripple Voltage

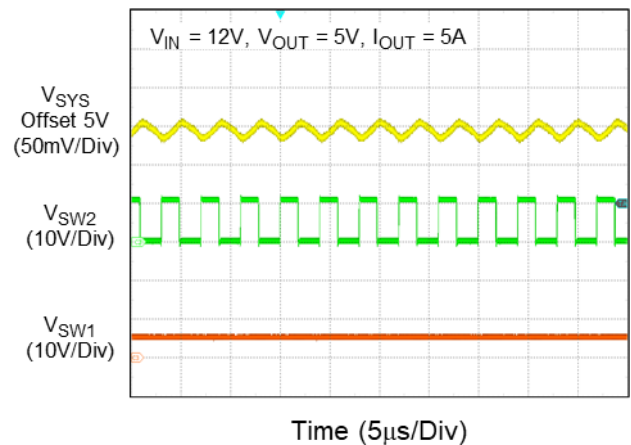

Forward Boost Mode Output Ripple Voltage

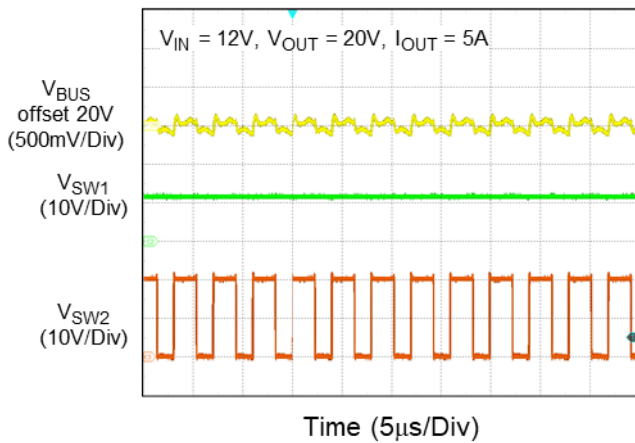

Reverse Boost Mode Output Ripple Voltage

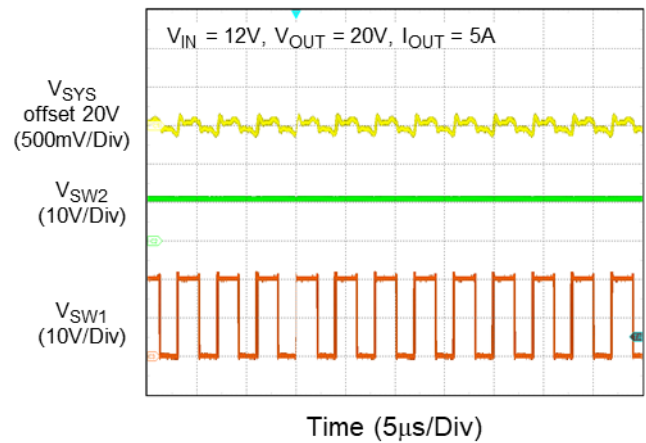

Forward Buck Mode Load Transient Response

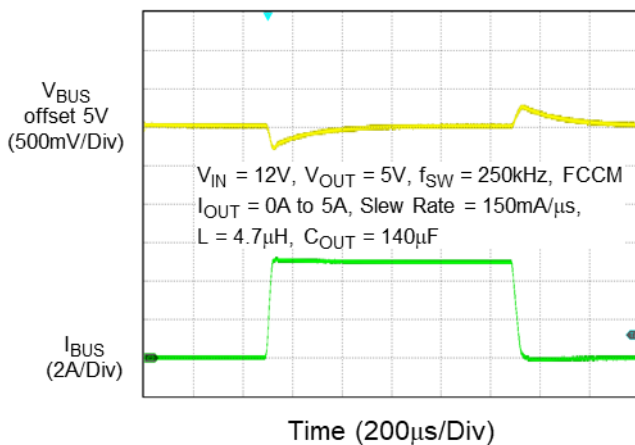

Reverse Buck Mode Load Transient Response

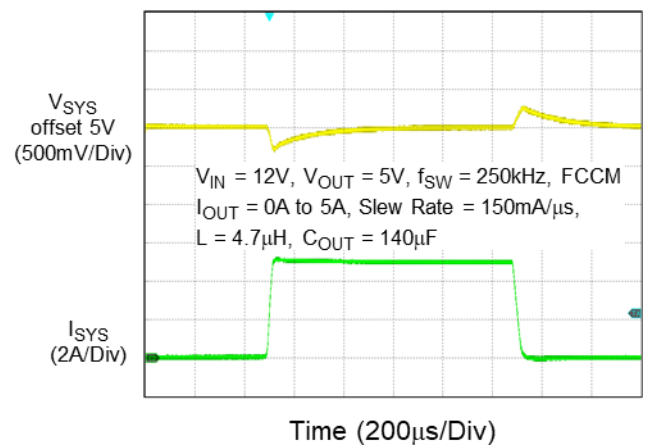

Forward Boost Mode Load Transient Response

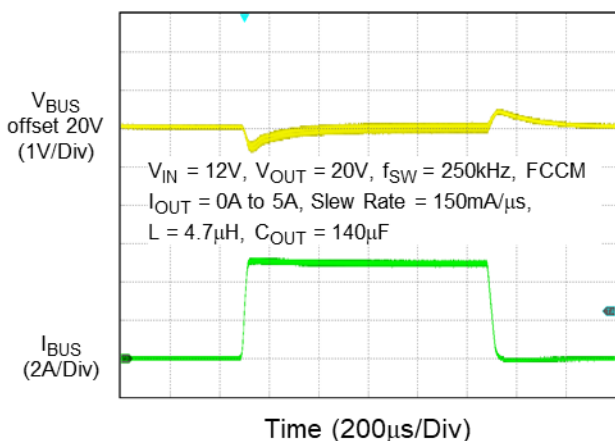

Reverse Boost Mode Load Transient Response

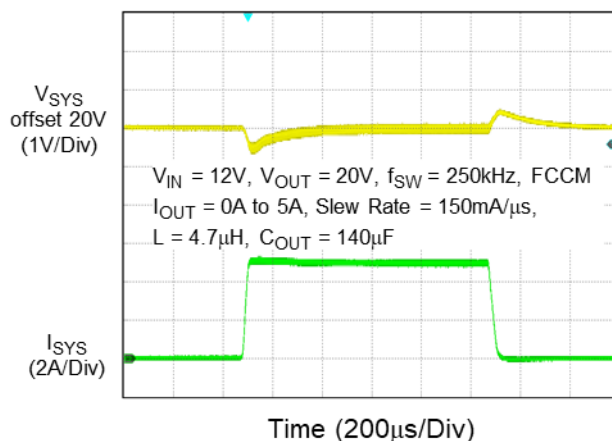

Forward Power-On from I²C

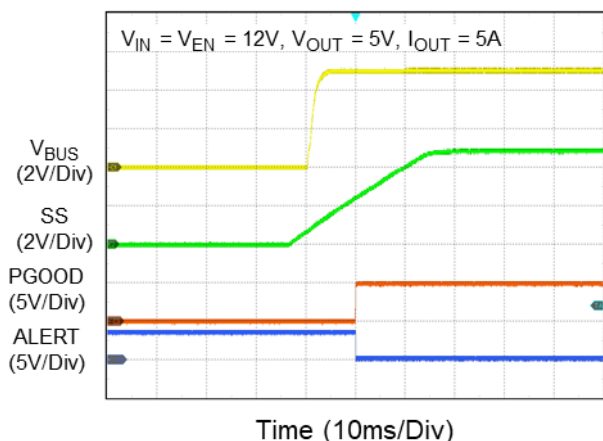

Reverse Power-On from I²C

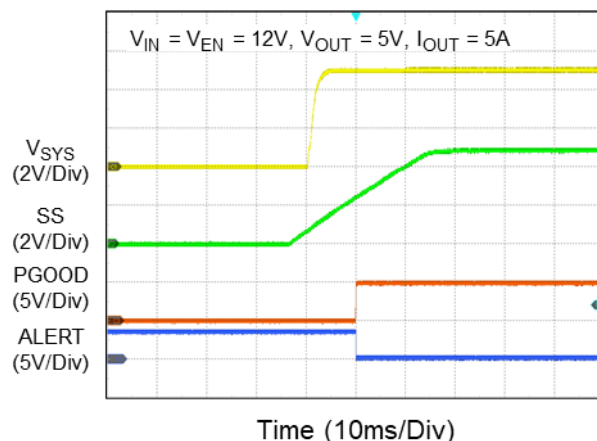

Forward Power-Off from I²C

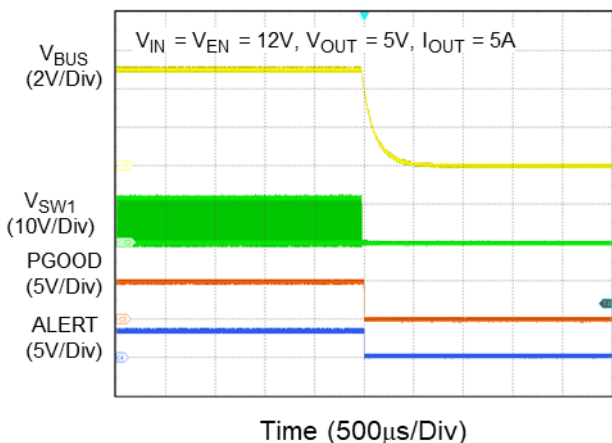

Reverse Power-Off from I²C

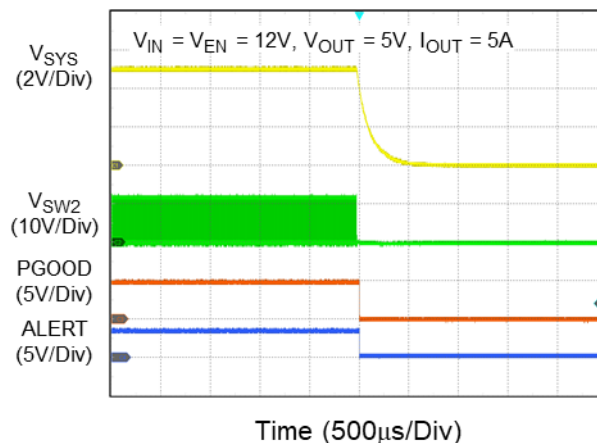

Evaluation Board Layout

Figure 1 to Figure 4 are RT6190GQW Evaluation Board layout.

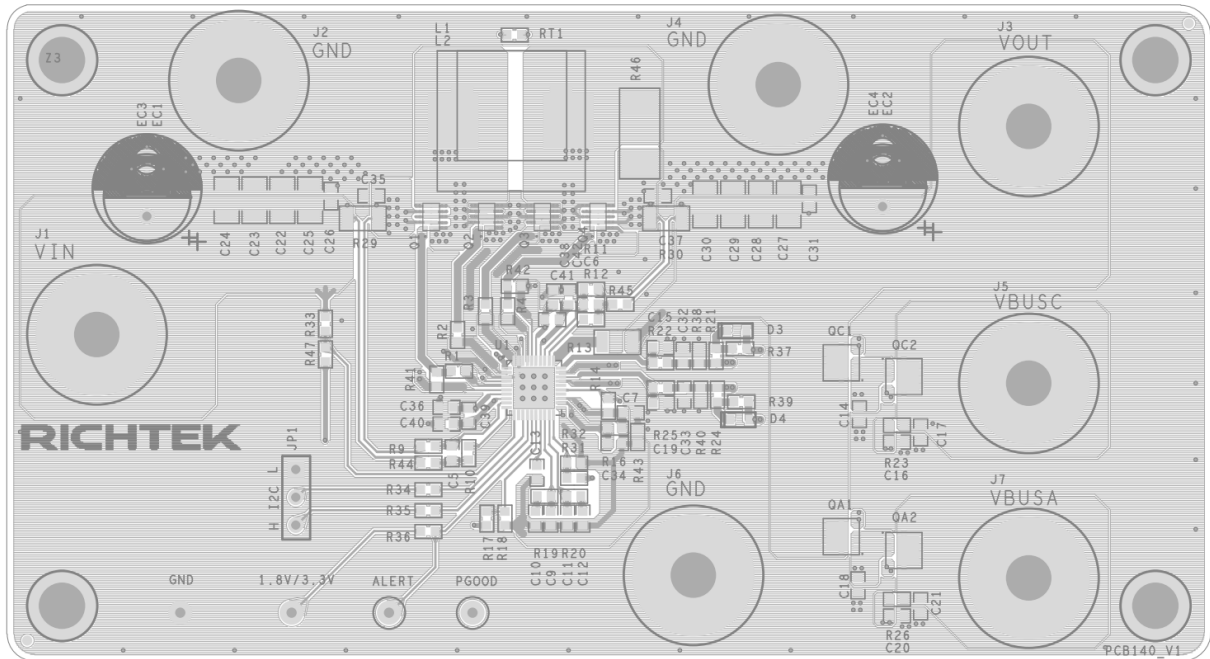

Figure 1. Top View (1st layer)

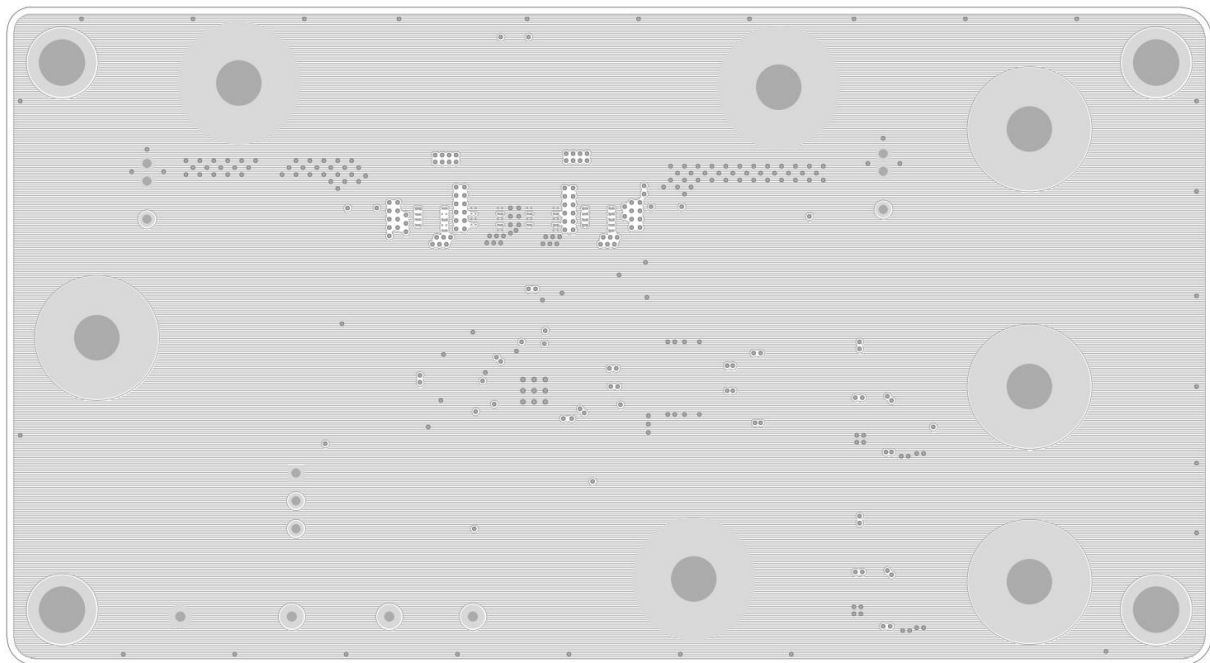

Figure 2. PCB Layout—Inner Side (2nd Layer)

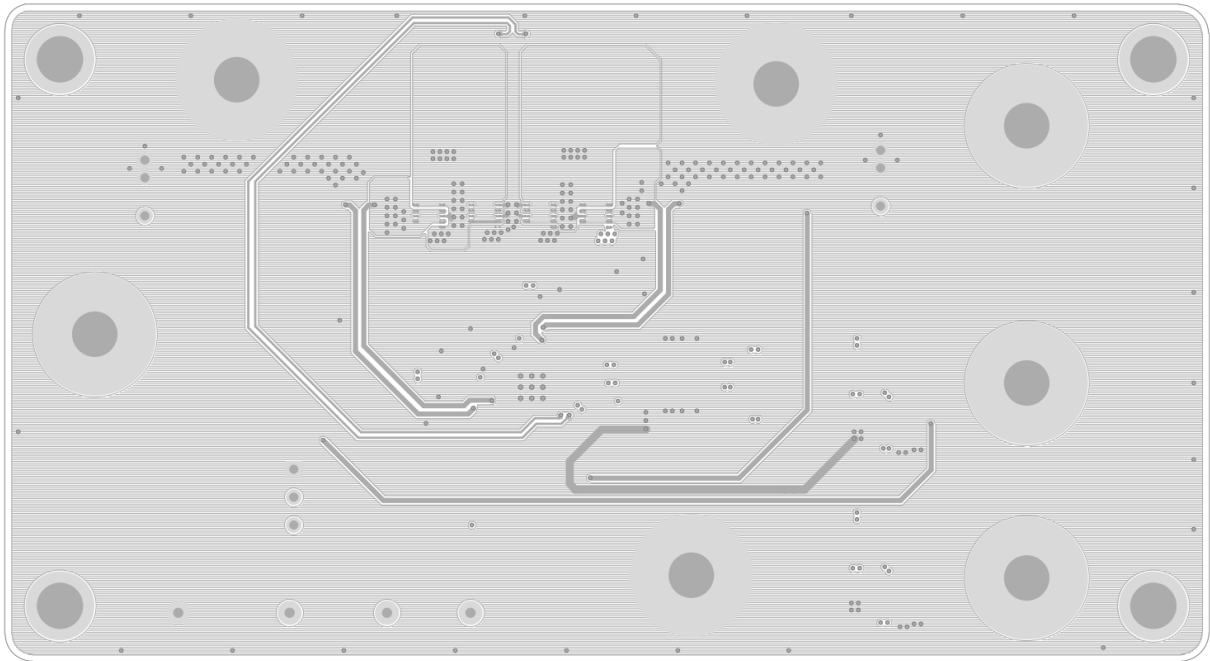

Figure 3. PCB Layout—Inner Side (3rd Layer)

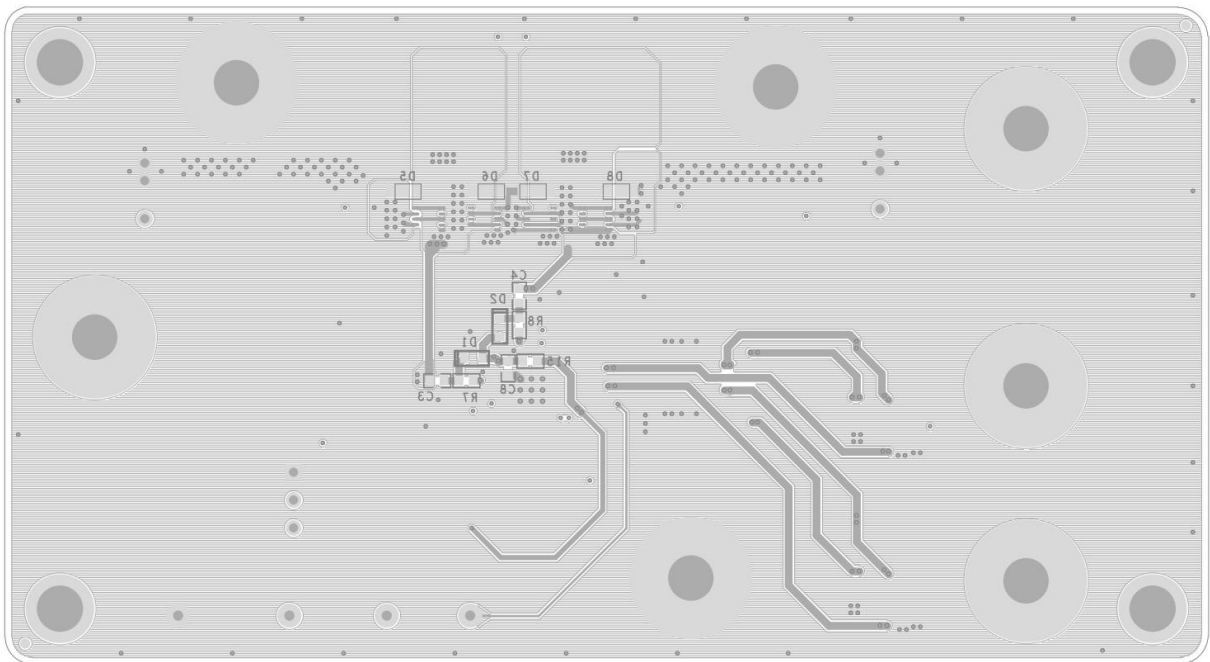

Figure 4. Bottom View (4th Layer)

More Information

For more information, please find the related datasheet or application notes from Richtek website <http://www.richtek.com>.

Important Notice for Richtek Evaluation Board

THIS DOCUMENT IS FOR REFERENCE ONLY, NOTHING CONTAINED IN THIS DOCUMENT SHALL BE CONSTRUED AS RICHTEK'S WARRANTY, EXPRESS OR IMPLIED, UNDER CONTRACT, TORT OR STATUTORY, WITH RESPECT TO THE PRESENTATION HEREIN. IN NO EVENT SHALL RICHTEK BE LIABLE TO BUYER OR USER FOR ANY AND ALL DAMAGES INCLUDING WITHOUT LIMITATION TO DIRECT, INDIRECT, SPECIAL, PUNITIVE OR CONSEQUENTIAL DAMAGES.